

Features

- Isolation voltage 3500 V~
- Industrial Standard Package
- High Surge Capability
- Glass Passivated Chips
- Simple Mounting
- Electrically Isolated by DBC Ceramic



Applications

- DC Motor Control and Drives
- Battery Charges
- Welders
- Power Converters
- Lighting Control
- Heat and Temperature Control

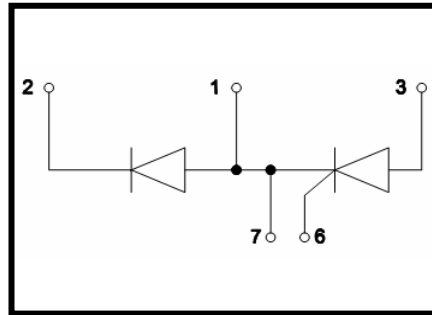

Advantages

- Space and weight savings
- Improved temperature and power cycling

ABSOLUTE MAXIMUM RATINGS

$T_C=25^\circ\text{C}$ unless otherwise specified

Symbol	Test Condition	Value	Unit
V_{RRM}		1600	V
$I_{T(AV)}$	$T_C=85^\circ\text{C}$, 180° conduction, half sine wave;	90	A
$I_{T(RMS)}$	as AC switch;	190	A
I_{TSM}	$T_J=45^\circ\text{C}$, $t=10\text{ms}$ (50Hz), sine, $V_R=0$;	1500	A
	$T_J=45^\circ\text{C}$, $t=8.3\text{ms}$ (60Hz), sine, $V_R=0$;	1650	
	$T_J=45^\circ\text{C}$, $t=10\text{ms}$ (50Hz), sine, $V_R=V_{RRM}$;	1350	
	$T_J=45^\circ\text{C}$, $t=8.3\text{ms}$ (60Hz), sine, $V_R=V_{RRM}$;	1400	
I^2t	$T_J=45^\circ\text{C}$, $t=10\text{ms}$ (50Hz), sine, $V_R=0$;	11.2	K A ² s
	$T_J=45^\circ\text{C}$, $t=8.3\text{ms}$ (60Hz), sine, $V_R=0$;	13.6	
	$T_J=45^\circ\text{C}$, $t=10\text{ms}$ (50Hz), sine, $V_R=V_{RRM}$;	9.1	
	$T_J=45^\circ\text{C}$, $t=8.3\text{ms}$ (60Hz), sine, $V_R=V_{RRM}$;	9.8	
I_{DRM}/I_{RRM}	$T_J=130^\circ\text{C}$, $V_D=V_R=1600\text{V}$, gate open circuit;	20	mA
dV/dt	$T_J=130^\circ\text{C}$, exponential to 67% rated V_{DRM}	500	V/us
V_{ISOL}	50Hz, all terminals shorted, $t=1\text{s}$, $I_{ISOL}\leq 1\text{mA}$;	3500	V~
T_J	Max. junction operating temperature range	-40~130	°C
T_{STG}	Max. storage temperature range	-40~150	°C

ELECTRICAL CHARACTERISTICST_C=25°C unless otherwise specified

Symbol	Test Condition	Min.	Typ.	Max.	Unit
V _{TO}	16.7% x p x I _{AV} < I < p x I _{AV} , T _J =130°C;			0.80	V
	I > p x I _{AV} , T _J =130°C;			0.85	V
r _t	16.7% x p x I _{AV} < I < p x I _{AV} , T _J =130°C;			2.37	mΩ
	I > p x I _{AV} , T _J =130°C;			2.25	mΩ
I _H	V _{AK} = 6V, resistive load;			250	mA
I _L	Anode supply =6V, resistive load=1Ω, gate pulse =10V, 100us;			400	mA
V _{TM}	I _{TM} =282A, t _d =10 ms, half sine		1.60		V
P _{GM}	t _p ≤5ms, T _J =125°C;			12	W
P _{GM(AV)}	f=50Hz, T _J =125°C;			3	W
I _{GM}	t _p ≤5ms, T _J =125°C;			3	A
-V _{GT}				10	V
V _{GT}	V _A =6V, R _A =1Ω, T _J =-40°C;			4	V
	V _A =6V, R _A =1Ω;			2.5	
	V _A =6V, R _A =1Ω, T _J =125°C;			1.7	
I _{GT}	V _A =6V, R _A =1Ω, T _J =-40°C;			270	mA
	V _A =6V, R _A =1Ω;			150	
	V _A =6V, R _A =1Ω, T _J =125°C;			80	
V _{GD}	V _{AK} =V _{DRM} , T _J =125°C			0.25	V
I _{GD}				6	mA
di/dt	T _J = 25°C, V _D =0.67V _{DRM} , I _{TM} =345A, I _g = 500mA, tr < 0.5 μs, tp > 6 μs			150	A/us

THERMAL AND MECHANICAL CHARACTERISTICST_C=25°C unless otherwise specified

Symbol	Test Condition	value	Unit
R _{thjc}	DC operation,per junction;	0.35	K/W
R _{THCS}	Mounting surface smooth,flat and greased,per junction	0.1	K/W
Md	Mounting torque(M5)	3 to 5	N·m
	Terminal connection torque(M5)		
Weight	Typical value	105	g

Characteristic curves

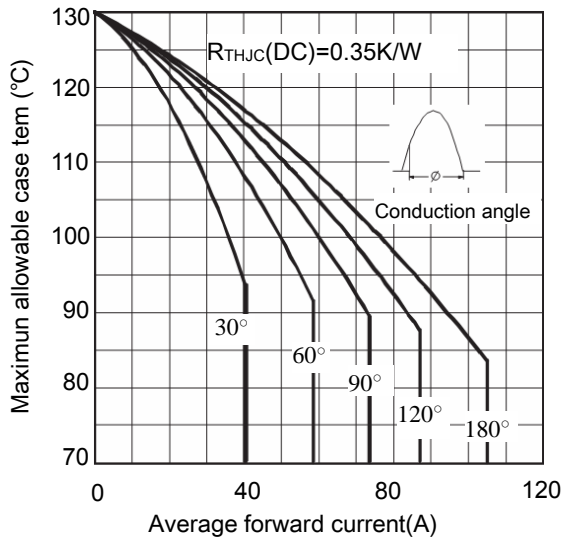

Figure 1. current rating characteristics

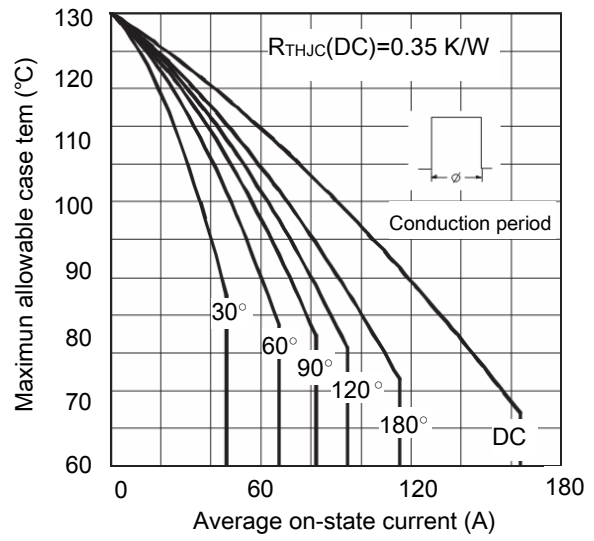

Figure 2. current rating characteristics

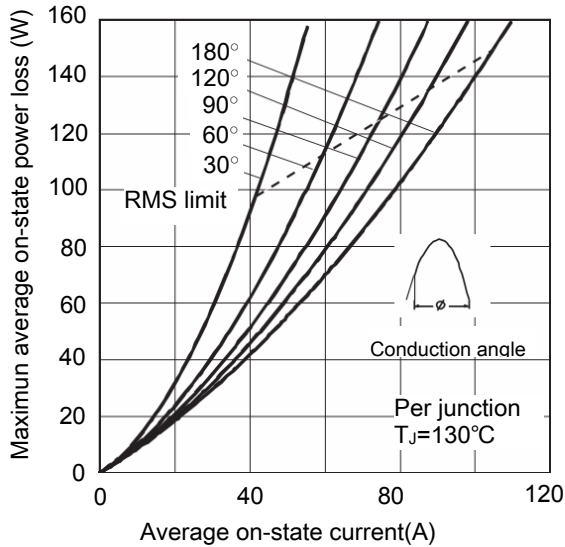

Figure 3. on-state power loss characteristics

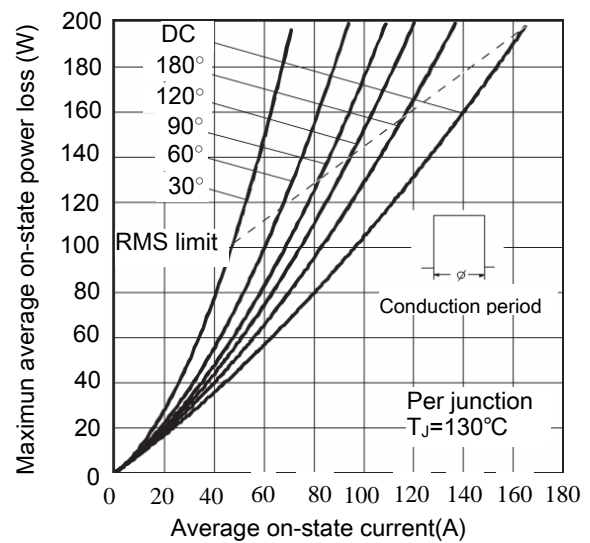

Figure 4. on-state power loss characteristics

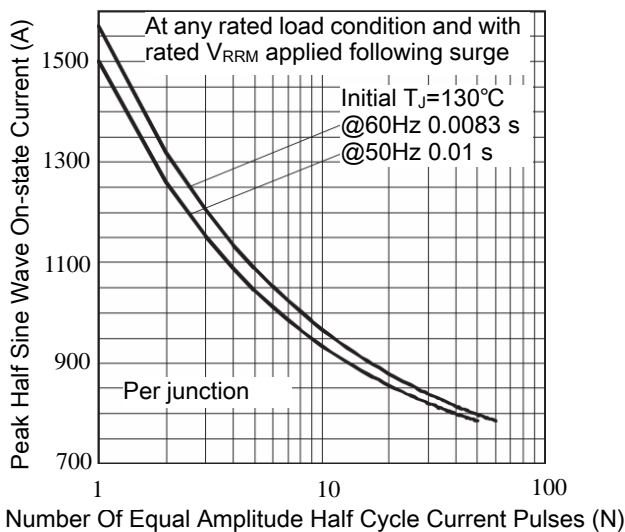

Figure 5. Maximum Non-Repetitive Surge Current

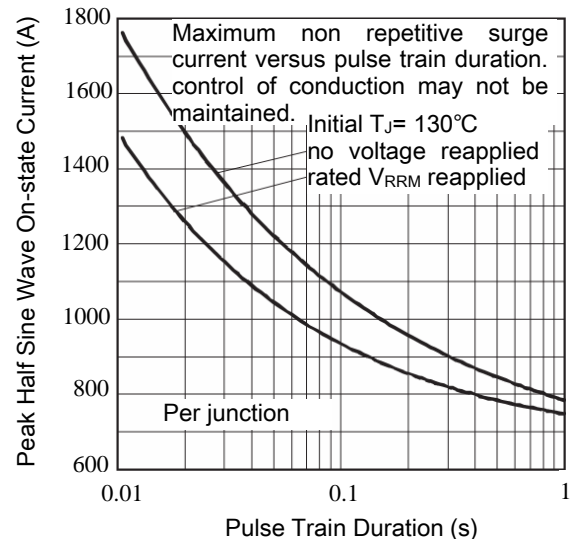

Figure 6. Maximum Non-Repetitive Surge Current

MMK90A160UK

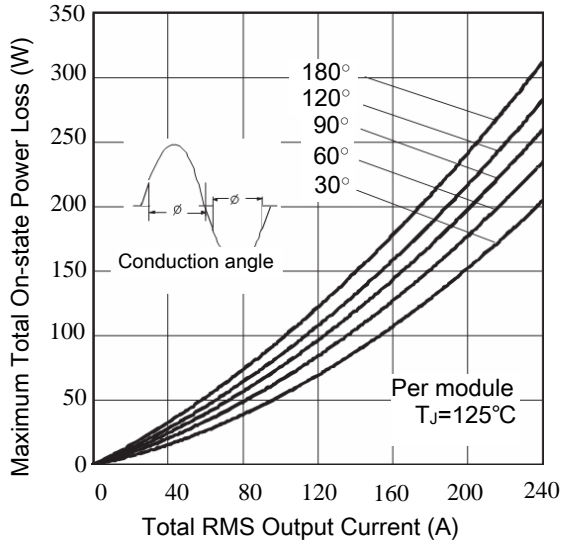

Figure 7. On-State Power Loss Characteristics-1

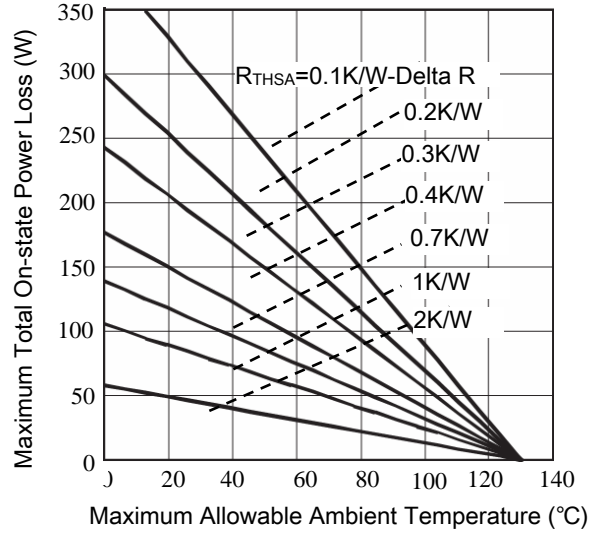

Figure.8 On-State Power Loss Characteristics-2

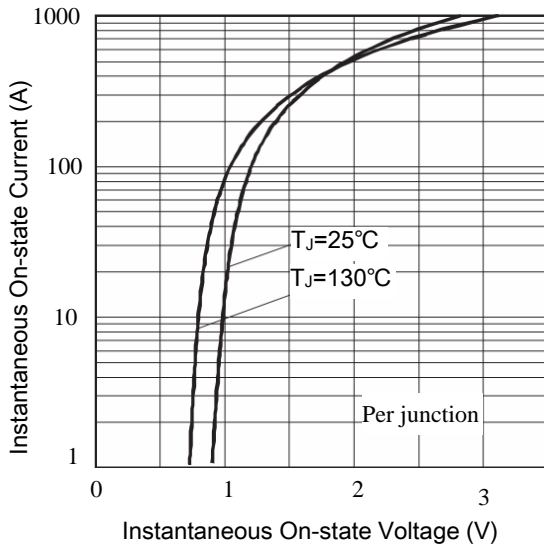

Figure.9 On State Voltage Drop Characteristics

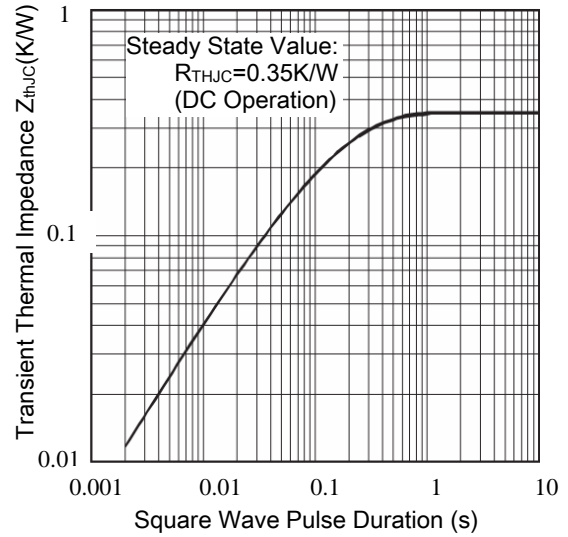

Figure.10 Thermal Impedance ZthJC Characteristics

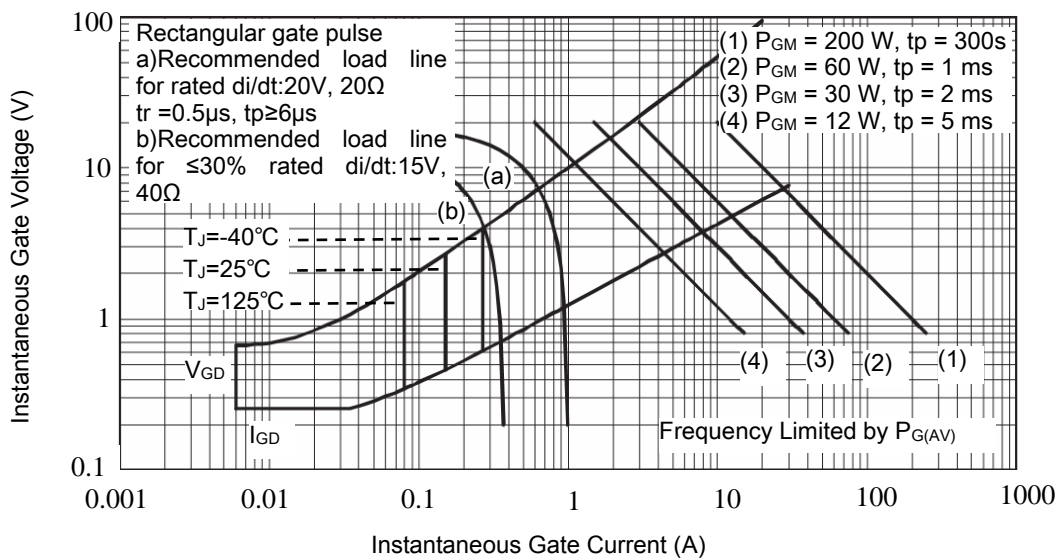

Figure.11 Gate Characteristics

Package Outline (Dimensions in mm)

