

# Technische Information / Technical Information

IGBT-Module  
IGBT-Modules

## BSM200GA120DLC

eupec



**vorläufige Daten**  
**preliminary data**

### Höchstzulässige Werte / Maximum rated values

#### Elektrische Eigenschaften / Electrical properties

Kollektor-Emitter-Sperrspannung collector-emitter voltage		$V_{CES}$	1200	V
Kollektor-Dauergleichstrom DC-collector current	$T_C = 80\text{ °C}$	$I_{C,nom.}$	200	A
	$T_C = 25\text{ °C}$	$I_C$	370	A
Periodischer Kollektor Spitzenstrom repetitive peak collector current	$t_p = 1\text{ ms}, T_C = 80\text{ °C}$	$I_{CRM}$	400	A
Gesamt-Verlustleistung total power dissipation	$T_C = 25\text{ °C}, \text{ Transistor}$	$P_{tot}$	1470	W
Gate-Emitter-Spitzenspannung gate-emitter peak voltage		$V_{GES}$	+/- 20V	V
Dauergleichstrom DC forward current		$I_F$	200	A
Periodischer Spitzenstrom repetitive peak forw. current	$t_p = 1\text{ ms}$	$I_{FRM}$	400	A
Grenzlastintegral der Diode $I^2t$ - value, Diode	$V_R = 0V, t_p = 10\text{ms}, T_{vj} = 125\text{ °C}$	$I^2t$	6,84	$\text{kJ}^2\text{s}$
Isolations-Prüfspannung insulation test voltage	RMS, $f = 50\text{ Hz}, t = 1\text{ min.}$	$V_{ISOL}$	2,5	kV

### Charakteristische Werte / Characteristic values

#### Transistor / Transistor

			min.	typ.	max.	
Kollektor-Emitter Sättigungsspannung collector-emitter saturation voltage	$I_C = 200A, V_{GE} = 15V, T_{vj} = 25\text{ °C}$	$V_{CE\text{ sat}}$	-	2,1	2,6	V
	$I_C = 200A, V_{GE} = 15V, T_{vj} = 125\text{ °C}$		-	2,4	t.b.d.	V
Gate-Schwellenspannung gate threshold voltage	$I_C = 8mA, V_{CE} = V_{GE}, T_{vj} = 25\text{ °C}$	$V_{GE(th)}$	4,5	5,5	6,5	V
Gateladung gate charge	$V_{GE} = -15V...+15V$	$Q_G$	-	t.b.d.	-	$\mu\text{C}$
Eingangskapazität input capacitance	$f = 1\text{MHz}, T_{vj} = 25\text{ °C}, V_{CE} = 25V, V_{GE} = 0V$	$C_{ies}$	-	13	-	nF
Rückwirkungskapazität reverse transfer capacitance	$f = 1\text{MHz}, T_{vj} = 25\text{ °C}, V_{CE} = 25V, V_{GE} = 0V$	$C_{res}$	-	t.b.d.	-	nF
Kollektor-Emitter Reststrom collector-emitter cut-off current	$V_{CE} = 1200V, V_{GE} = 0V, T_{vj} = 25\text{ °C}$	$I_{CES}$	-	20	500	$\mu\text{A}$
	$V_{CE} = 1200V, V_{GE} = 0V, T_{vj} = 125\text{ °C}$		-	500	-	$\mu\text{A}$
Gate-Emitter Reststrom gate-emitter leakage current	$V_{CE} = 0V, V_{GE} = 20V, T_{vj} = 25\text{ °C}$	$I_{GES}$	-	-	400	nA

prepared by: Mark Münzer	date of publication: 12.02.1999
approved by: Jens Thureau	revision: 1

# Technische Information / Technical Information

IGBT-Module  
IGBT-Modules

## BSM200GA120DLC

eupec



**vorläufige Daten**  
**preliminary data**

### Charakteristische Werte / Characteristic values

Transistor / Transistor		min.	typ.	max.		
Einschaltverzögerungszeit (ind. Last) turn on delay time (inductive load)	$I_C = 200A, V_{CC} = 600V$	$t_{d,on}$	-	0,09	-	$\mu s$
	$V_{GE} = \pm 15V, R_G = 4,7\Omega, T_{vj} = 25^\circ C$ $V_{GE} = \pm 15V, R_G = 4,7\Omega, T_{vj} = 125^\circ C$		-	0,09	-	$\mu s$
Anstiegszeit (induktive Last) rise time (inductive load)	$I_C = 200A, V_{CC} = 600V$	$t_r$	-	0,09	-	$\mu s$
	$V_{GE} = \pm 15V, R_G = 4,7\Omega, T_{vj} = 25^\circ C$ $V_{GE} = \pm 15V, R_G = 4,7\Omega, T_{vj} = 125^\circ C$		-	0,1	-	$\mu s$
Abschaltverzögerungszeit (ind. Last) turn off delay time (inductive load)	$I_C = 200A, V_{CC} = 600V$	$t_{d,off}$	-	0,54	-	$\mu s$
	$V_{GE} = \pm 15V, R_G = 4,7\Omega, T_{vj} = 25^\circ C$ $V_{GE} = \pm 15V, R_G = 4,7\Omega, T_{vj} = 125^\circ C$		-	0,59	-	$\mu s$
Fallzeit (induktive Last) fall time (inductive load)	$I_C = 200A, V_{CC} = 600V$	$t_f$	-	0,06	-	$\mu s$
	$V_{GE} = \pm 15V, R_G = 4,7\Omega, T_{vj} = 25^\circ C$ $V_{GE} = \pm 15V, R_G = 4,7\Omega, T_{vj} = 125^\circ C$		-	0,09	-	$\mu s$
Einschaltverlustenergie pro Puls turn-on energy loss per pulse	$I_C = 200A, V_{CC} = 600V, V_{GE} = 15V$ $R_G = 4,7\Omega, T_{vj} = 125^\circ C, L_S = 90nH$	$E_{on}$	-	18	-	mWs
Abschaltverlustenergie pro Puls turn-off energy loss per pulse	$I_C = 200A, V_{CC} = 600V, V_{GE} = 15V$ $R_G = 4,7\Omega, T_{vj} = 125^\circ C, L_S = 90nH$	$E_{off}$	-	25	-	mWs
Kurzschlußverhalten SC Data	$t_p \leq 10\mu sec, V_{GE} \leq 15V, R_G = 4,7\Omega$ $T_{vj} \leq 125^\circ C, V_{CC} = 900V, V_{CEmax} = V_{CES} - L_{sCE} \cdot di/dt$	$I_{SC}$	-	1250	-	A
Modulinduktivität stray inductance module		$L_{sCE}$	-	16	-	nH
Modul Leitungswiderstand, Anschlüsse – Chip module lead resistance, terminals – chip	$T_C = 25^\circ C$	$R_{CC+EE}$	-	0,5	-	m $\Omega$

### Charakteristische Werte / Characteristic values

Diode / Diode		min.	typ.	max.		
Durchlaßspannung forward voltage	$I_F = 200A, V_{GE} = 0V, T_{vj} = 25^\circ C$	$V_F$	-	1,8	2,3	V
	$I_F = 200A, V_{GE} = 0V, T_{vj} = 125^\circ C$		-	1,7	t.b.d.	V
Rückstromspitze peak reverse recovery current	$I_F = 200A, -di_F/dt = 2100A/\mu sec$	$I_{RM}$	-	180	-	A
	$V_R = 600V, V_{GE} = -15V, T_{vj} = 25^\circ C$ $V_R = 600V, V_{GE} = -15V, T_{vj} = 125^\circ C$		-	240	-	A
Sperrverzögerungsladung recovered charge	$I_F = 200A, -di_F/dt = 2100A/\mu sec$	$Q_r$	-	24	-	$\mu As$
	$V_R = 600V, V_{GE} = -15V, T_{vj} = 25^\circ C$ $V_R = 600V, V_{GE} = -15V, T_{vj} = 125^\circ C$		-	43	-	$\mu As$
Abschaltenergie pro Puls reverse recovery energy	$I_F = 200A, -di_F/dt = 2100A/\mu sec$	$E_{rec}$	-	7	-	mWs
	$V_R = 600V, V_{GE} = -15V, T_{vj} = 25^\circ C$ $V_R = 600V, V_{GE} = -15V, T_{vj} = 125^\circ C$		-	16	-	mWs

# Technische Information / Technical Information

IGBT-Module  
IGBT-Modules

## BSM200GA120DLC

eupec

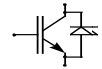

### vorläufige Daten preliminary data

#### Thermische Eigenschaften / Thermal properties

		min.		typ.	max.	
Innerer Wärmewiderstand thermal resistance, junction to case	Transistor / transistor, DC	$R_{thJC}$	-	-	0,085	K/W
	Diode/Diode, DC		-	-	0,15	K/W
Übergangs-Wärmewiderstand thermal resistance, case to heatsink	pro Modul / per module $\lambda_{Paste} = 1 \text{ W/m} \cdot \text{K}$ / $\lambda_{grease} = 1 \text{ W/m} \cdot \text{K}$	$R_{thCK}$	-	0,010	-	K/W
Höchstzulässige Sperrschichttemperatur maximum junction temperature		$T_{vj}$	-	-	150	°C
Betriebstemperatur operation temperature		$T_{op}$	-40	-	125	°C
Lagertemperatur storage temperature		$T_{stg}$	-40	-	150	°C

#### Mechanische Eigenschaften / Mechanical properties

Gehäuse, siehe Anlage case, see appendix					
Innere Isolation internal insulation				AL <sub>2</sub> O <sub>3</sub>	
Kriechstrecke creepage distance				20	mm
Luftstrecke clearance				11	mm
CTI comperative tracking index				225	
Anzugsdrehmoment f. mech. Befestigung mounting torque	screw M5	M1	3	6	Nm
Anzugsdrehmoment f. elektr. Anschlüsse terminal connection torque	terminals M6		2,5	5,0	Nm
	terminals M4		1,1	2,0	Nm
Gewicht weight		G		300	g

Mit dieser technischen Information werden Halbleiterbauelemente spezifiziert, jedoch keine Eigenschaften zugesichert. Sie gilt in Verbindung mit den zugehörigen Technischen Erläuterungen.

This technical information specifies semiconductor devices but promises no characteristics. It is valid in combination with the belonging technical notes.

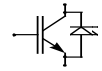

**Ausgangskennlinie (typisch)**  
**Output characteristic (typical)**

$I_C = f(V_{CE})$   
 $V_{GE} = 15V$

**vorläufige Daten**  
**preliminary data**

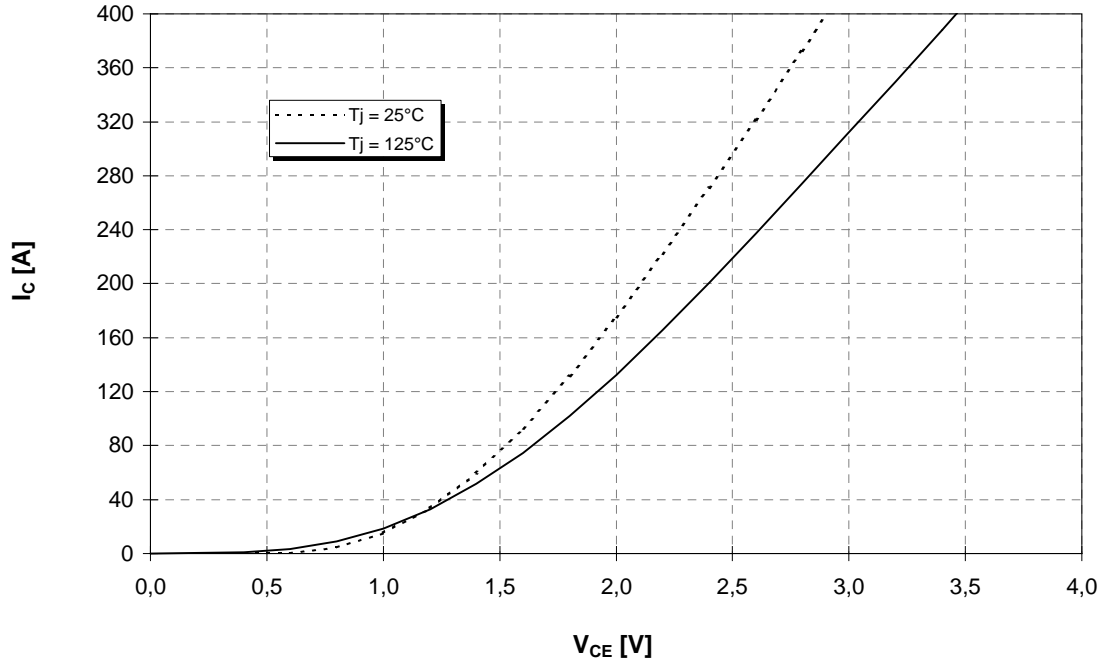

**Ausgangskennlinienfeld (typisch)**  
**Output characteristic (typical)**

$I_C = f(V_{CE})$   
 $T_{vj} = 125°C$

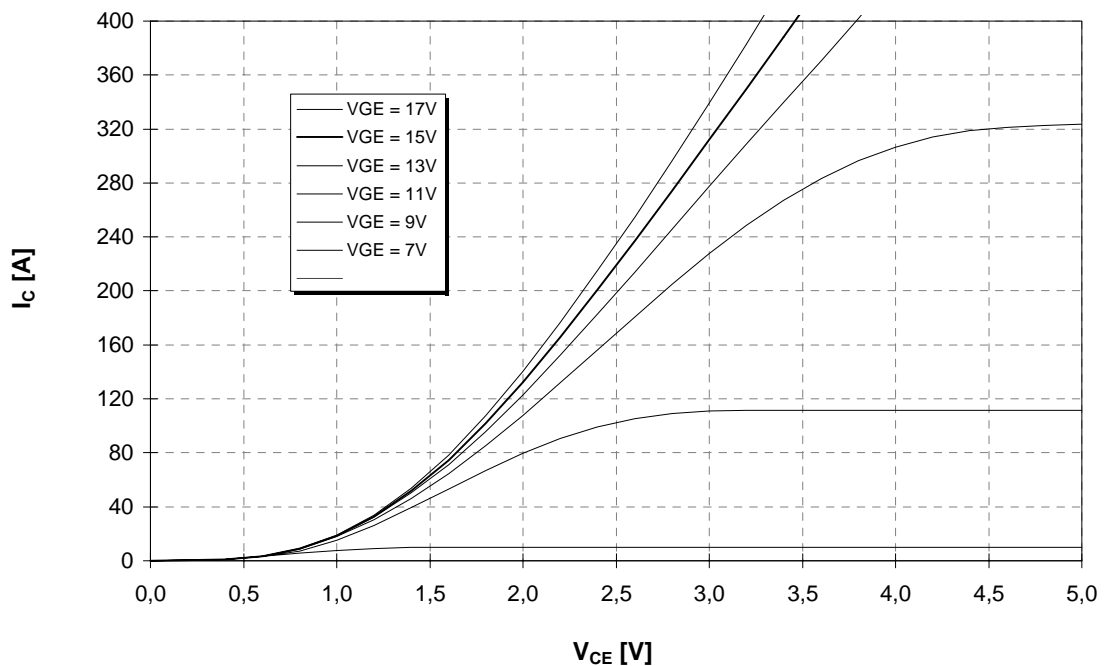

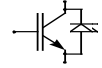

**vorläufige Daten**  
**preliminary data**

**Übertragungscharakteristik (typisch)**  
**Transfer characteristic (typical)**

$I_C = f(V_{GE})$   
 $V_{CE} = 20V$

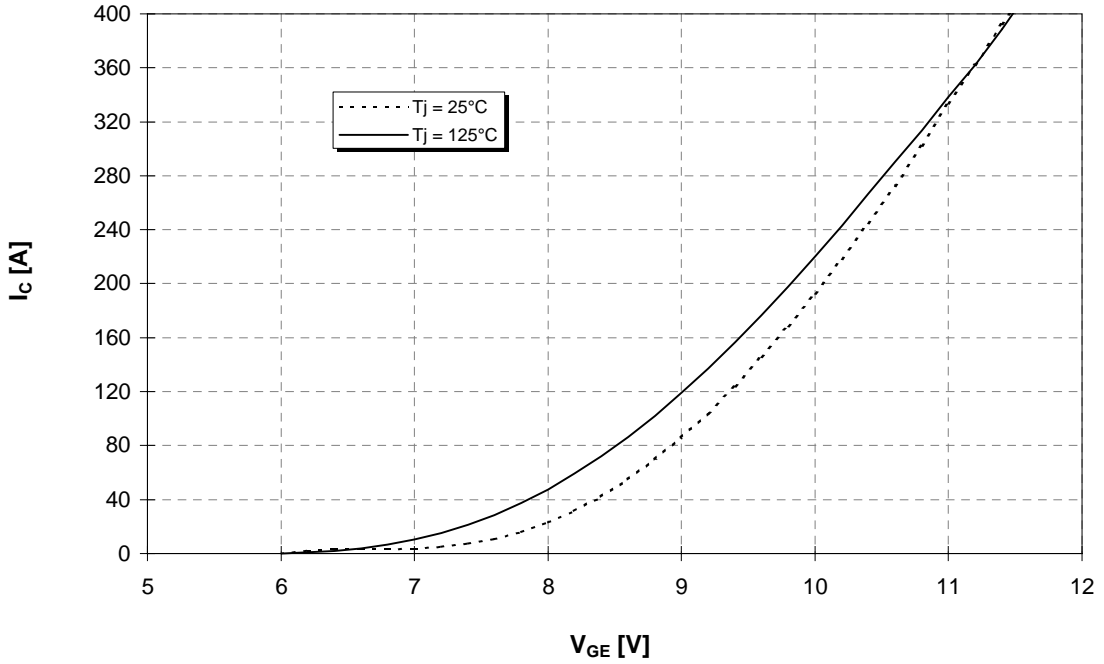

**Durchlaßkennlinie der Inversdiode (typisch)**  
**Forward characteristic of inverse diode (typical)**

$I_F = f(V_F)$

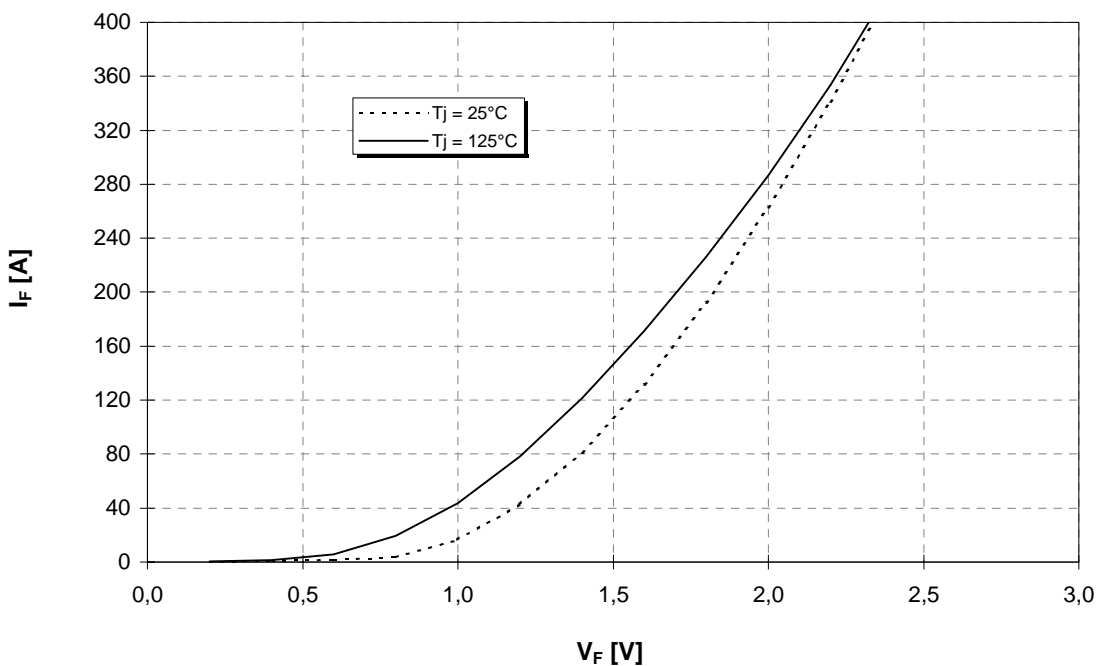

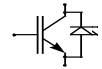

**vorläufige Daten**  
**preliminary data**

**Schaltverluste (typisch)  $E_{on} = f(I_C)$ ,  $E_{off} = f(I_C)$ ,  $E_{rec} = f(I_C)$**   
**Switching losses (typical)  $V_{GE}=15V$ ,  $R_{gon} = R_{goff} = 4,7 \Omega$ ,  $V_{CE} = 600V$ ,  $T_j = 125^\circ C$**

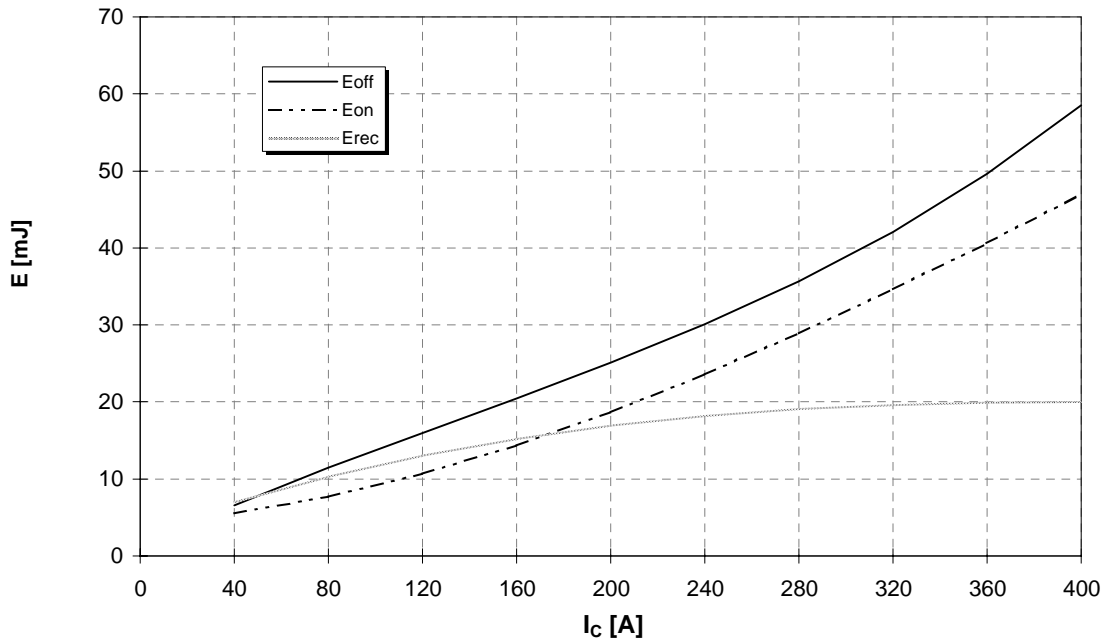

**Schaltverluste (typisch)  $E_{on} = f(R_G)$ ,  $E_{off} = f(R_G)$ ,  $E_{rec} = f(R_G)$**   
**Switching losses (typical)  $V_{GE}=15V$ ,  $I_C = 200A$ ,  $V_{CE} = 600V$ ,  $T_j = 125^\circ C$**

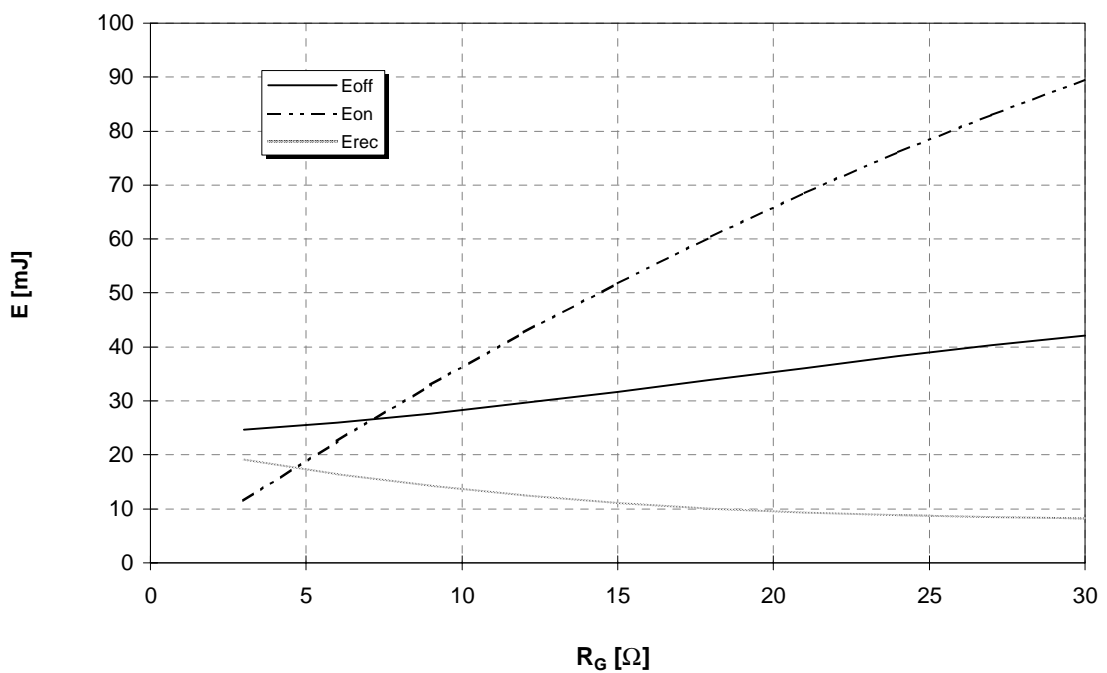



vorläufige Daten

preliminary data

Transienter Wärmewiderstand  
Transient thermal impedance

$$Z_{thJC} = f(t)$$

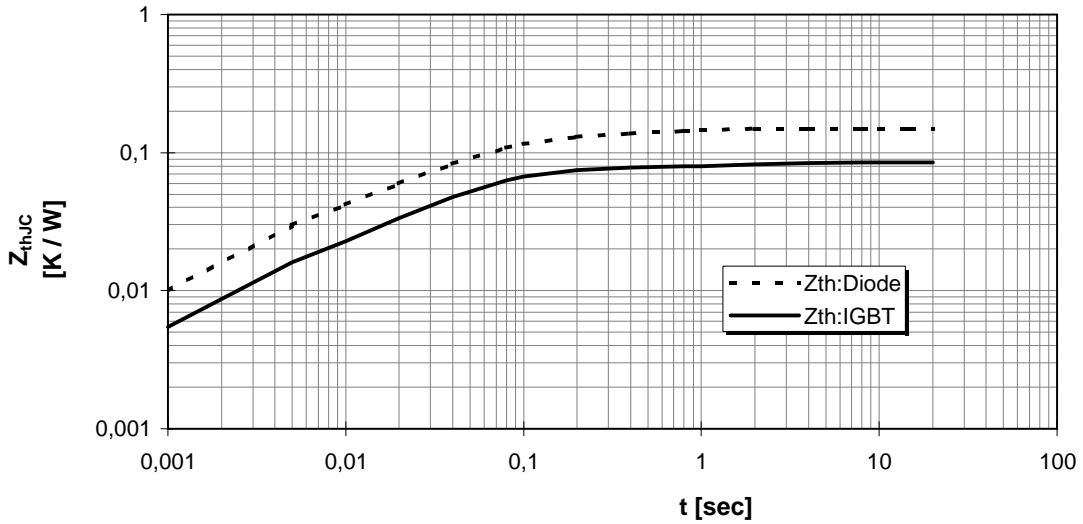

i	1	2	3	4
$r_i$ [K/kW] : IGBT	9,51	28,77	37,49	9,23
$\tau_i$ [sec] : IGBT	0,00002	0,004	0,048	0,500
$r_i$ [K/kW] : Diode	19,63	51,99	56,73	21,65
$\tau_i$ [sec] : Diode	0,002	0,03	0,072	0,682

Sicherer Arbeitsbereich (RBSOA)

Reverse bias safe operation area (RBSOA)

$V_{GE} = 15V, R_g = 4,7 \text{ Ohm}, T_{vj} = 125^\circ C$

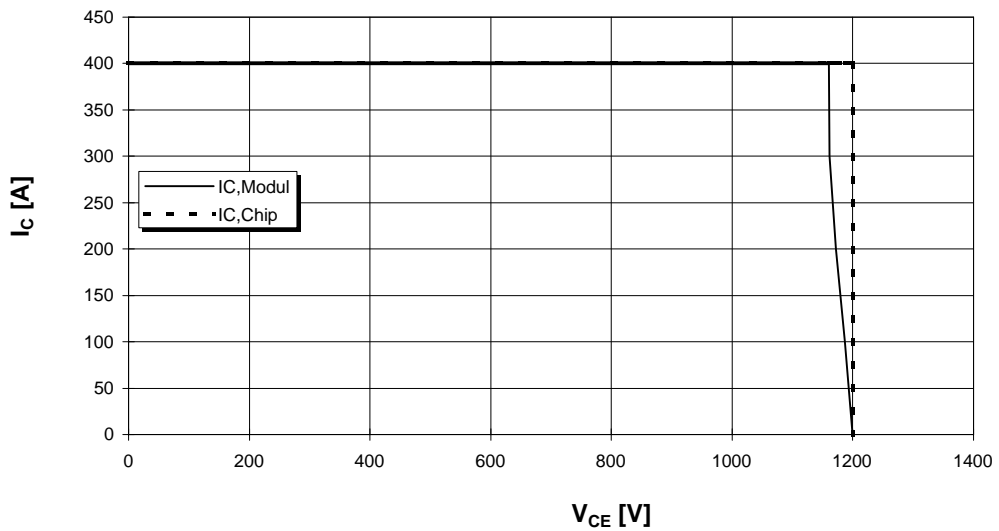

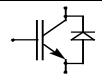

vorläufige Daten

preliminary data

# Single Switch 62

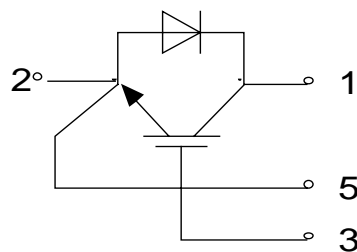
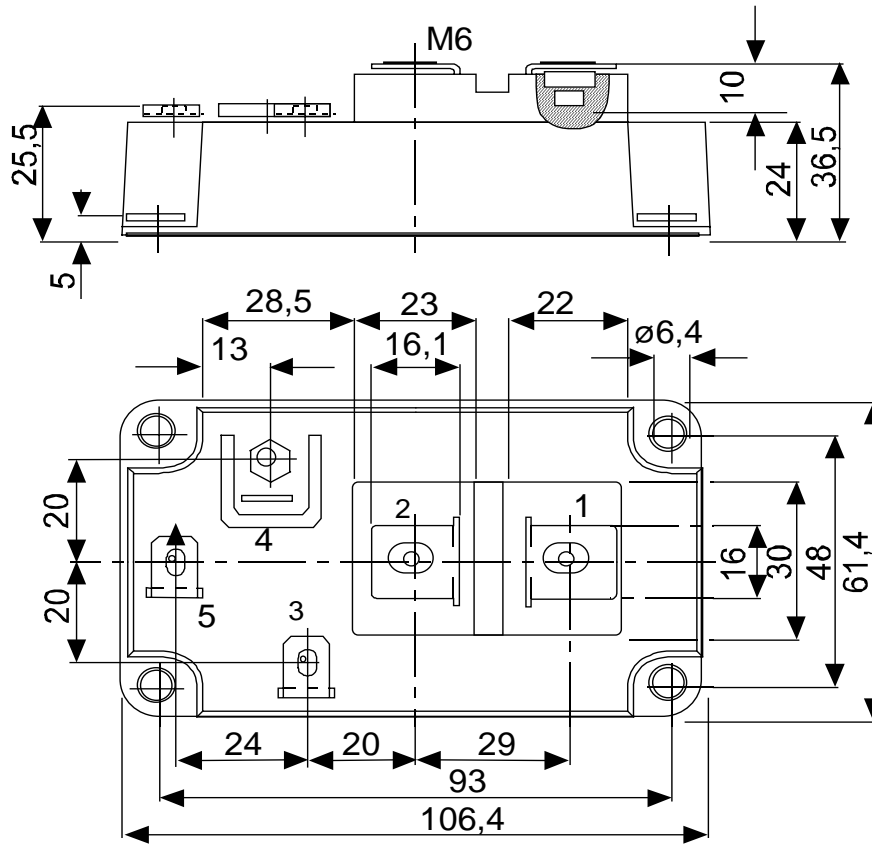

IS6